

## IP65 SEALED DUAL-COMPARTMENT ENCLOSURE



### PRODUCT INFORMATION

- 5 different sizes of wall mounting cases with separate terminal compartment for you to use in measurement & control application.
- These cases are able to be used with din EN60715 rail (35mm).
- Hinge type of transparent cover (left-hand or right-hand hinge) for you to view the terminal, open and close the cover easily.
- Fastening pillars and guide grooves for vertical and horizontal installation of printed circuit boards.
- PG or Metric rated break points are designed for you to use the IP68 cable glands (PG or Metric type) well.

#### TYPE A

DCXXXCUL SERIES



#### TYPE B

DCXXXCBU SERIES

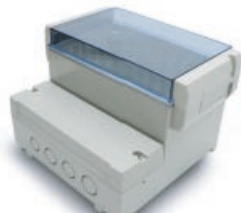

#### TYPE C

DCXXXCBUNO SERIES



#### TYPE D

DCXXXLGN0 SERIES



# DCXXXCUL SERIES

DC001CUL, DC003CUL, DC005CUL, DC007CUL, DC009CUL

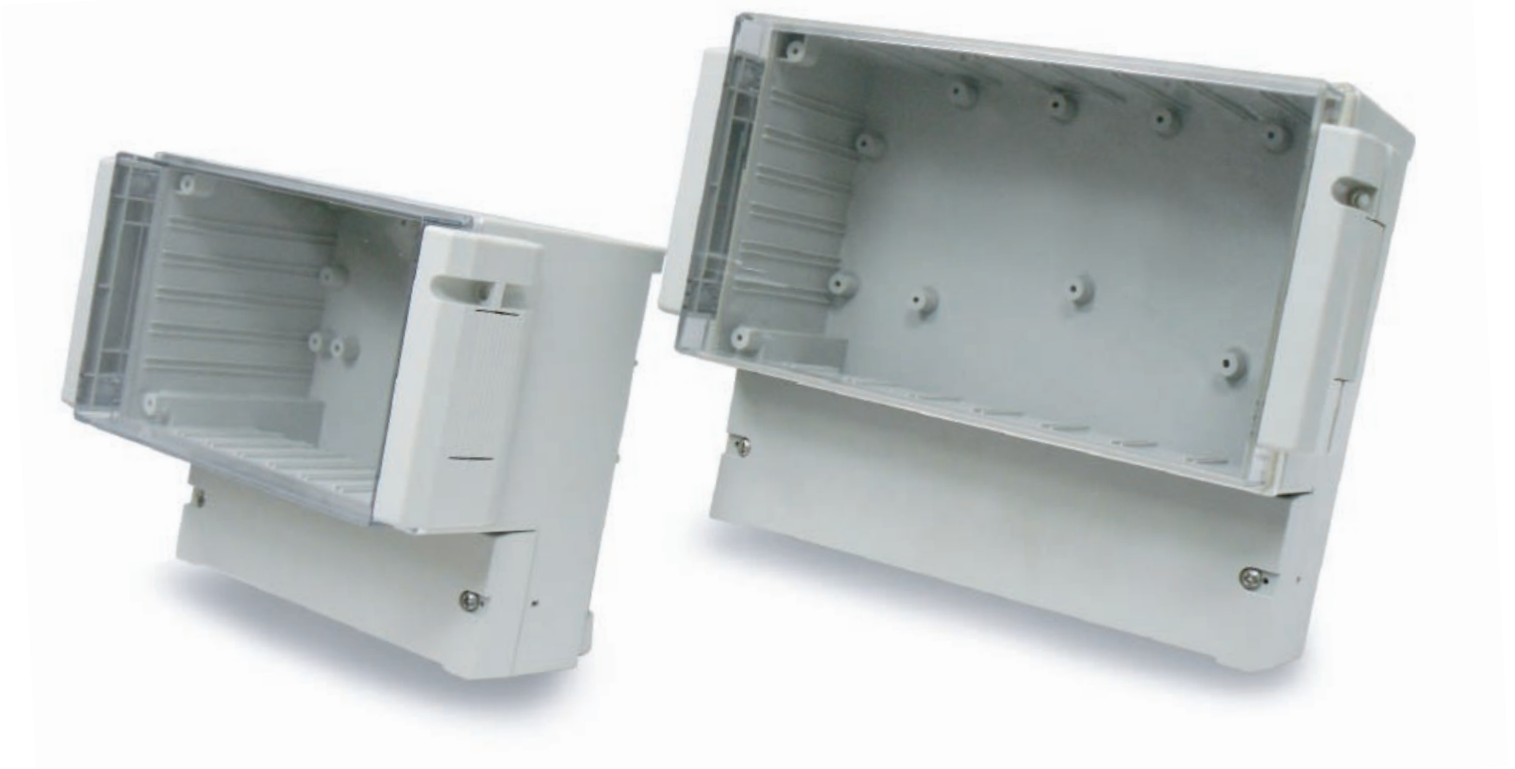

Example: DC001CUL



## PRODUCT INFORMATION

- Material: UL94-V0 rating of PC/ABS (grey base, grey lid, hinge kit)  
UL94-V0 rating of Polycarbonate (transparent lid)
- Color: Light grey, similar to RAL7038 with transparent lid.
- Recommended working temperature: -40°C to +120°C
- Ingress Protection: IP65 certified, EPDM gasket pre-installed.

Gasket pre-installed



Transparent lid

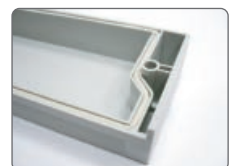

Terminal compartment lid

ITEM No.	MATERIAL	EXTERNAL DIMENSION(mm)
DC001CUL	PC/ABS, UL94-V0	166 x 161 x 93
DC003CUL	PC/ABS, UL94-V0	166 x 161 x 121
DC005CUL	PC/ABS, UL94-V0	213 x 185 x 104.5
DC007CUL	PC/ABS, UL94-V0	256 x 217 x 132.5
DC009CUL	PC/ABS, UL94-V0	296 x 281 x 158

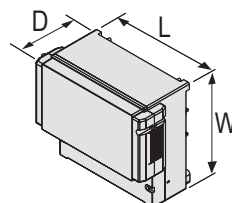

# DCXXXCBU SERIES

DC001CBU, DC003CBU, DC005CBU, DC007CBU, DC009CBU



Example: DC003CBU



## PRODUCT INFORMATION

- Material: UL94-HB rating of ABS (grey base, gray lid, hinge kit)  
UL94-HB rating of Polycarbonate (Transparent blue lid)
- Color: Light grey, similar to RAL 7035 with transparent blue lid.
- Recommended working temperature: -20°C to +80°C
- Ingress Protection: IP65 certified, EPDM gasket pre-installed.

Gasket pre-installed



Transparent blue lid

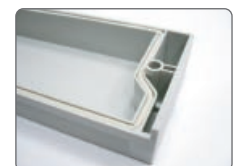

Terminal compartment lid

ITEM No.	MATERIAL	EXTERNAL DIMENSION(mm)
<b>DC001CBU</b>	ABS, UL94-HB	166 x 161 x 93
<b>DC003CBU</b>	ABS, UL94-HB	166 x 161 x 121
<b>DC005CBU</b>	ABS, UL94-HB	213 x 185 x 104.5
<b>DC007CBU</b>	ABS, UL94-HB	256 x 217 x 132.5
<b>DC009CBU</b>	ABS, UL94-HB	296 x 281 x 158

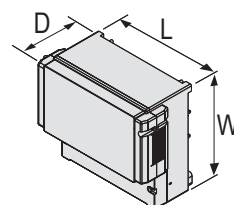

# DCXXxCBUNO SERIES

DC001CBUNO, DC003CBUNO, DC005CBUNO  
DC007CBUNO, DC009CBUNO



Example: DC009CBUNO



## PRODUCT INFORMATION

- Material: UL94-HB rating of ABS(Grey base, gray lid)
- UL94-HB rating of Polycarbonate(Transparent blue lid)
- Color: Light grey, similar to RAL 7035 with transparent blue lid.
- Recommended working temperature: -20°C to +80°C.
- Ingress Protection: IP 65 certified, EPDM gasket pre-installed.

Gasket pre-installed



Transparent blue lid

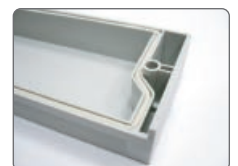

Terminal compartment lid

ITEM No.	MATERIAL	EXTERNAL DIMENSION(mm)
DC001CBUNO	ABS, UL94-HB	166 x 161 x 93
DC003CBUNO	ABS, UL94-HB	166 x 161 x 121
DC005CBUNO	ABS, UL94-HB	213 x 185 x 104.5
DC007CBUNO	ABS, UL94-HB	256 x 217 x 132.5
DC009CBUNO	ABS, UL94-HB	296 x 281 x 158

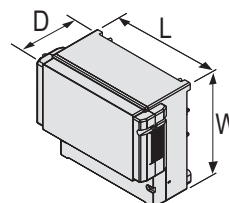



# DCXXXLGNO SERIES

DC001LGNO, DC003LGNO, DC005LGNO  
DC007LGNO, DC009LGNO



Example: DC005LGNO



## PRODUCT INFORMATION

- Material: UL94-HB rating of ABS.
- Color: Light grey, similar to RAL 7035.
- Recommended working temperature: -20°C to +80°C.
- Ingress Protection: IP 65 certified, EPDM gasket pre-installed.

Gasket pre-installed



Gray lid

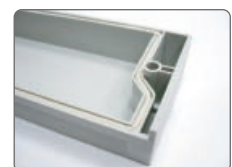

Terminal compartment lid

ITEM No.	MATERIAL	EXTERNAL DIMENSION(mm)
DC001LGNO	ABS, UL94-HB	166 x 161 x 93
DC003LGNO	ABS, UL94-HB	166 x 161 x 121
DC005LGNO	ABS, UL94-HB	213 x 185 x 104.5
DC007LGNO	ABS, UL94-HB	256 x 217 x 132.5
DC009LGNO	ABS, UL94-HB	296 x 281 x 158

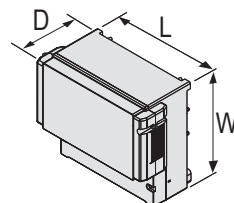

# CONTENT

## TYPE A DCXXXCUL SERIES

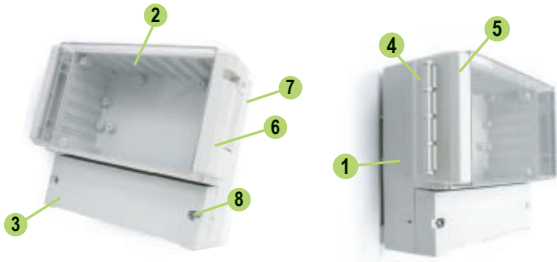

1. Cabinets

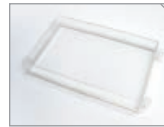

2. Transparent lid



3. Terminal compartment lid



4. Hinge clip



5. Hinge bar



6. Locking hook



7. Lower locking hook



8. Screws for terminal compartment lid use  
remark: M4X25MM self tapping screws(2pcs)

## TYPE B DCXXXCBU SERIES



1. Cabinets



2. Transparent blue lid



3. Terminal compartment lid



4. Hinge clip



5. Hinge bar



6. Locking hook



7. Lower locking hook



8. Screws for terminal compartment lid use  
remark: M4X25MM self tapping screws(2pcs)

## TYPE C DCXXXCBUNO SERIES

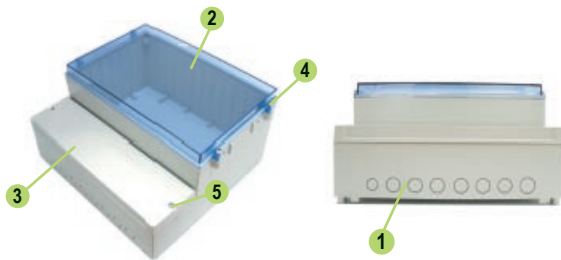

1. Cabinets



2. Transparent blue lid



3. Terminal compartment lid



4. Screws for transparent blue lid use  
remark: M5.5X27MM self tapping screws(4pcs)



5. Screws for terminal compartment lid use  
remark: M4X25MM self tapping screws(2pcs)

## TYPE D DCXXXLGNO SERIES

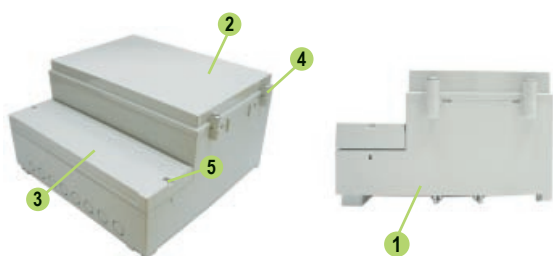

1. Cabinets

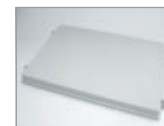

2. Grey lid



3. Terminal compartment lid



4. Screws for grey lid use  
remark: M5.5X27MM self tapping screws(4pcs)



5. Screws for terminal compartment lid use  
remark: M4X25MM self tapping screws(2pcs)

# ASSEMBLY INSTRUCTION

FOR DCXXXCUL SERIES (TYPE A), DCXXXCBU(TYPE B)

## Left-hand hinge

1. To assemble the ⑤ hinge bar on the left side of the ① cabinets.
2. To assemble the ⑦ lower locking hook on the right side of the ① cabinets.
3. To assemble the ④ hinge clip on the left side of the ② transparent lid.
4. To assemble the ⑥ locking hook on the right side of the ② transparent lid.

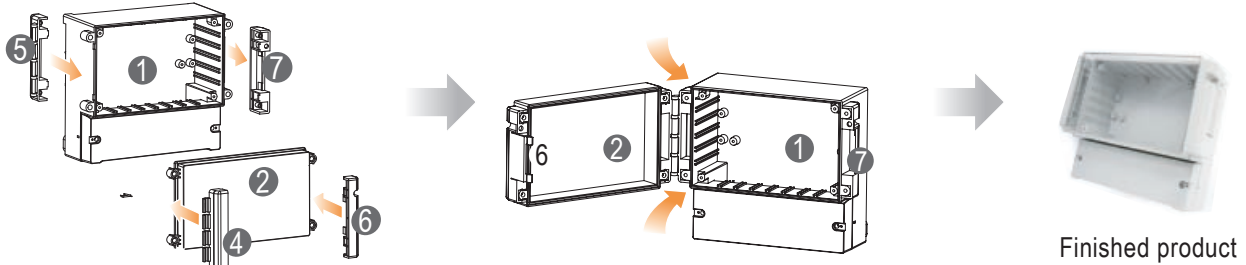

## Right-hand hinge

1. To assemble the ⑦ lower locking hook on the left side of the ① cabinets.
2. To assemble the ⑤ hinge bar on the right side of the ① cabinets.
3. To assemble the ⑥ locking hook on the left side of the ② transparent lid.
4. To assemble the ④ hinge clip on the right side of the ② transparent lid.

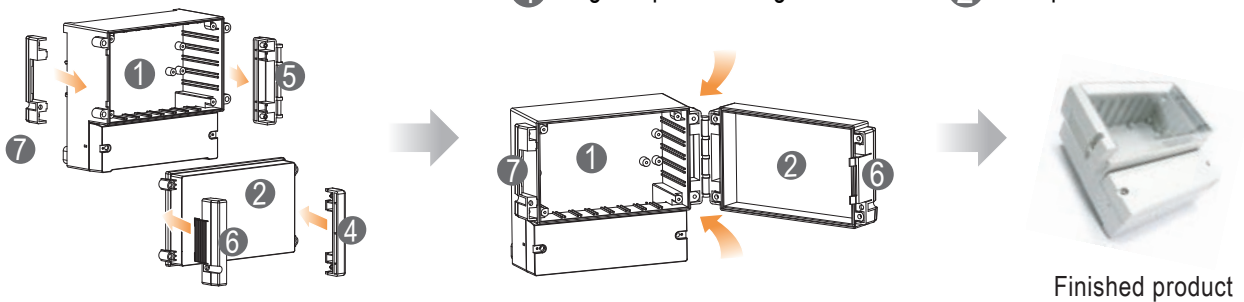

## OTHER FEATURES

### Mounting brackets (Optional)

Can be assembled with the mounting brackets.



MF-001LG(4PCS)



\* Optional

### Designed to assemble with the IP68 cable glands (PG or Metric type).



1. For PG 9 or M12 use.
2. For PG11 or M16 use.
3. For PG11 or M16 use.
4. For PG13.5 or M20 use.



For PG11 or M16 use.

### Din EN60715 rail (35mm)

Can be assembled with the din EN60715 rail (35mm).



\* not supply

### Designed to assemble with the lock



\* not supply

# Example for The Drilling & Assembly of The Cable Gland with DC0XX Series of Plastic Box.

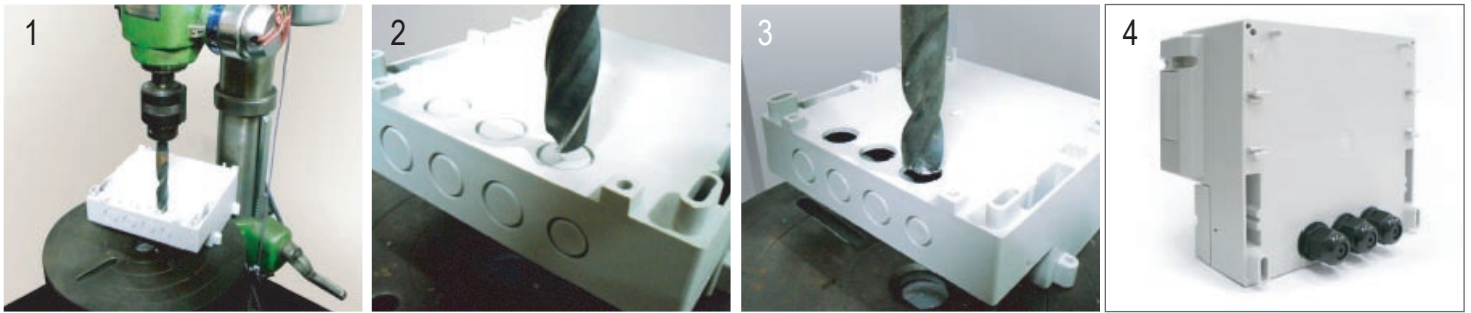

## Recommended bit size

**< A >**  
DIA 16.0 mm

**< B >**  
DIA 19.0 mm

**< C >**  
DIA 21.0 mm

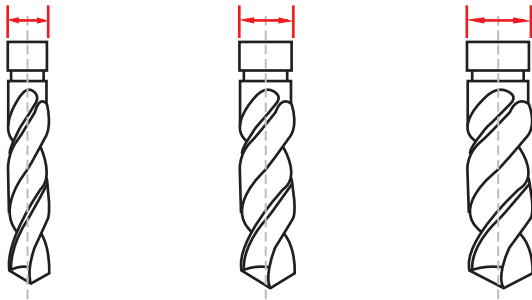

	Recommended bit size	Cable Gland
A	DIA 16.0 mm	PG9 (or M12)
B	DIA 19.0 mm	PG11 (or M16)
C	DIA 21.0 mm	PG13.5 (or M20)

### DC001CUL, DC001CBU, DC001LGNO, DC001CBUNO

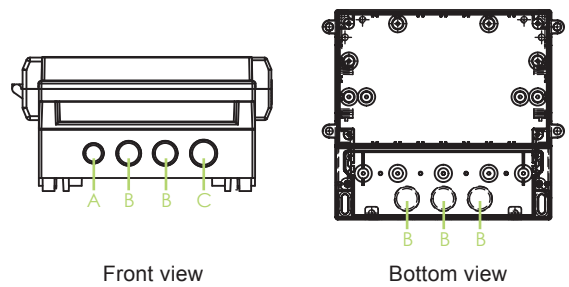

### DC003CUL, DC003CBU, DC003LGNO, DC003CBUNO

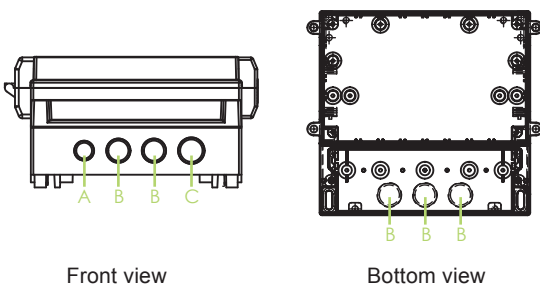

### DC005CUL, DC005CBU, DC005LGNO, DC005CBUNO

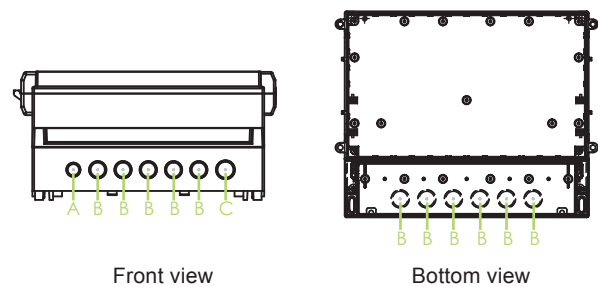

### DC007CUL, DC007CBU, DC007LGNO, DC007CBUNO

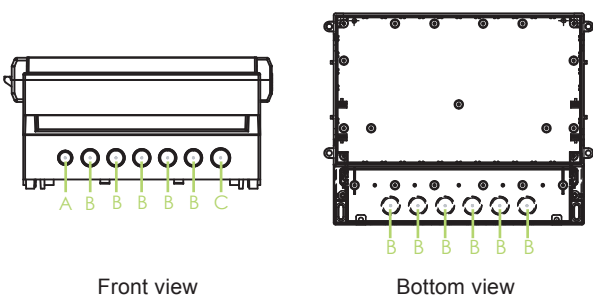

### DC009CUL, DC009CBU, DC009LGNO, DC009CBUNO

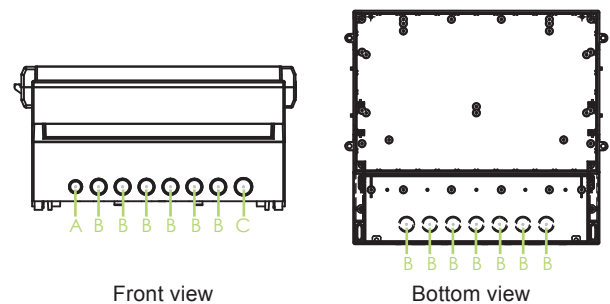



## DC001CUL/DC001CBU

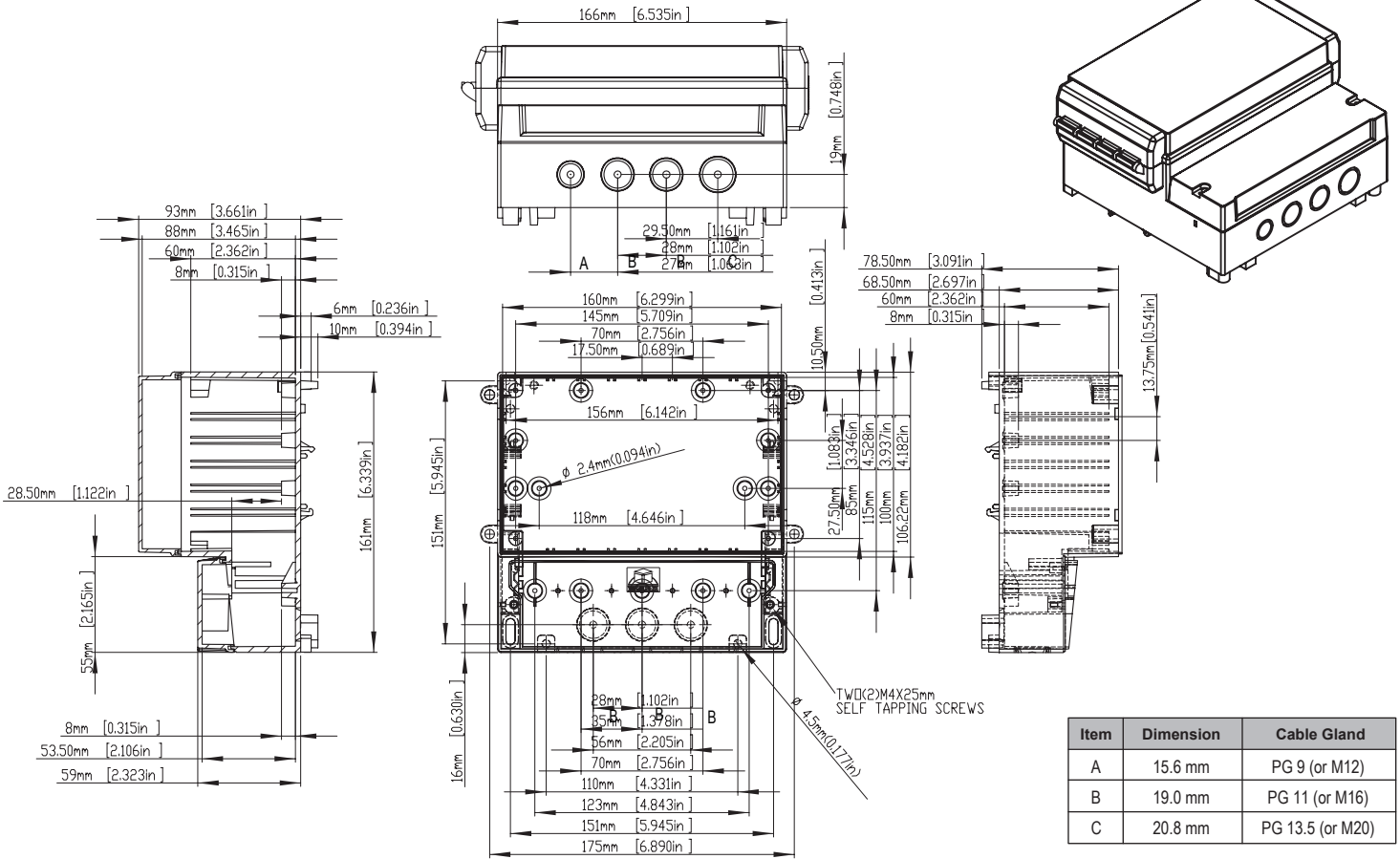

## DC001CBUNO/DC001LGNO

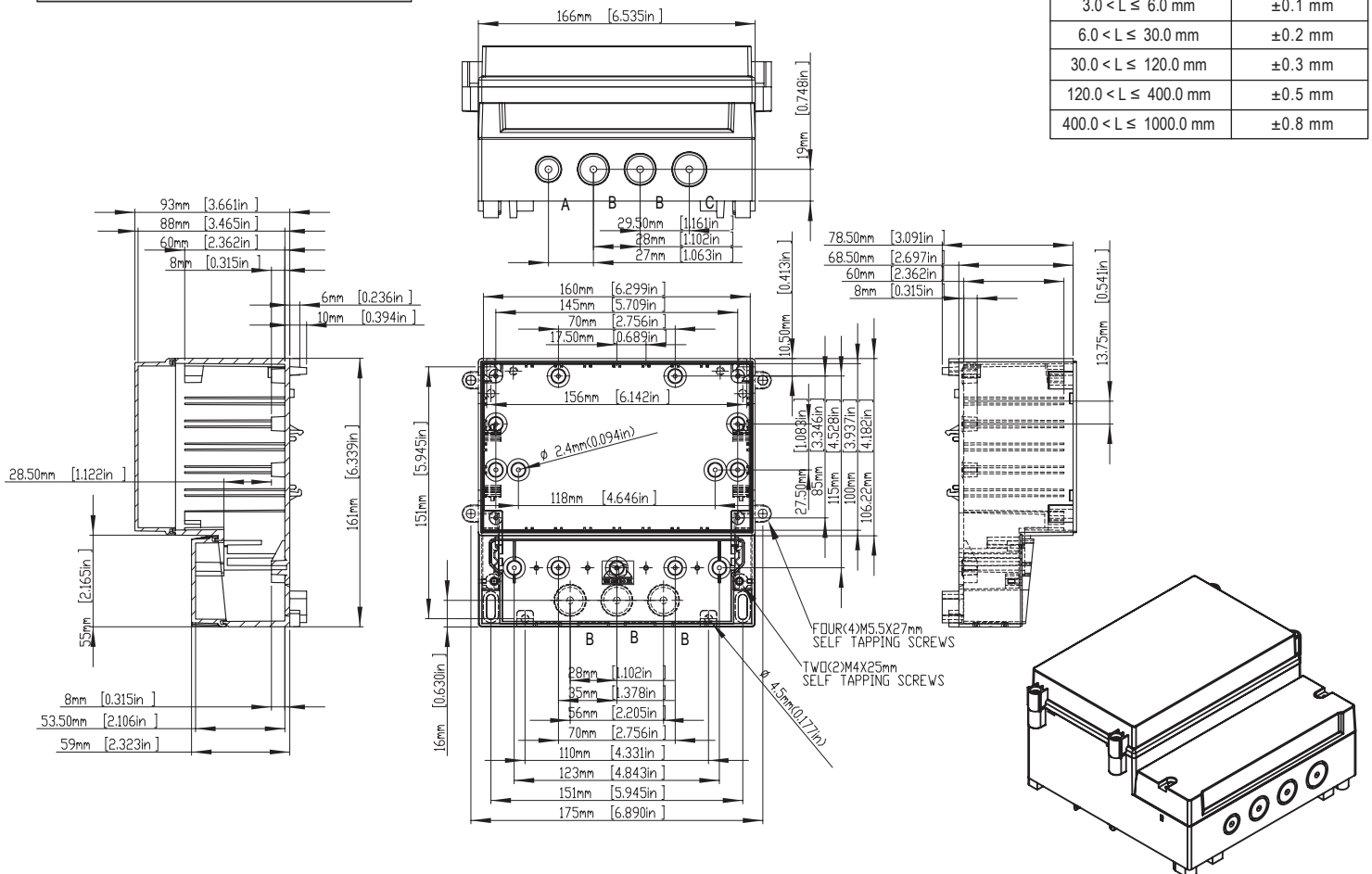

## DC003CUL/DC003CBU

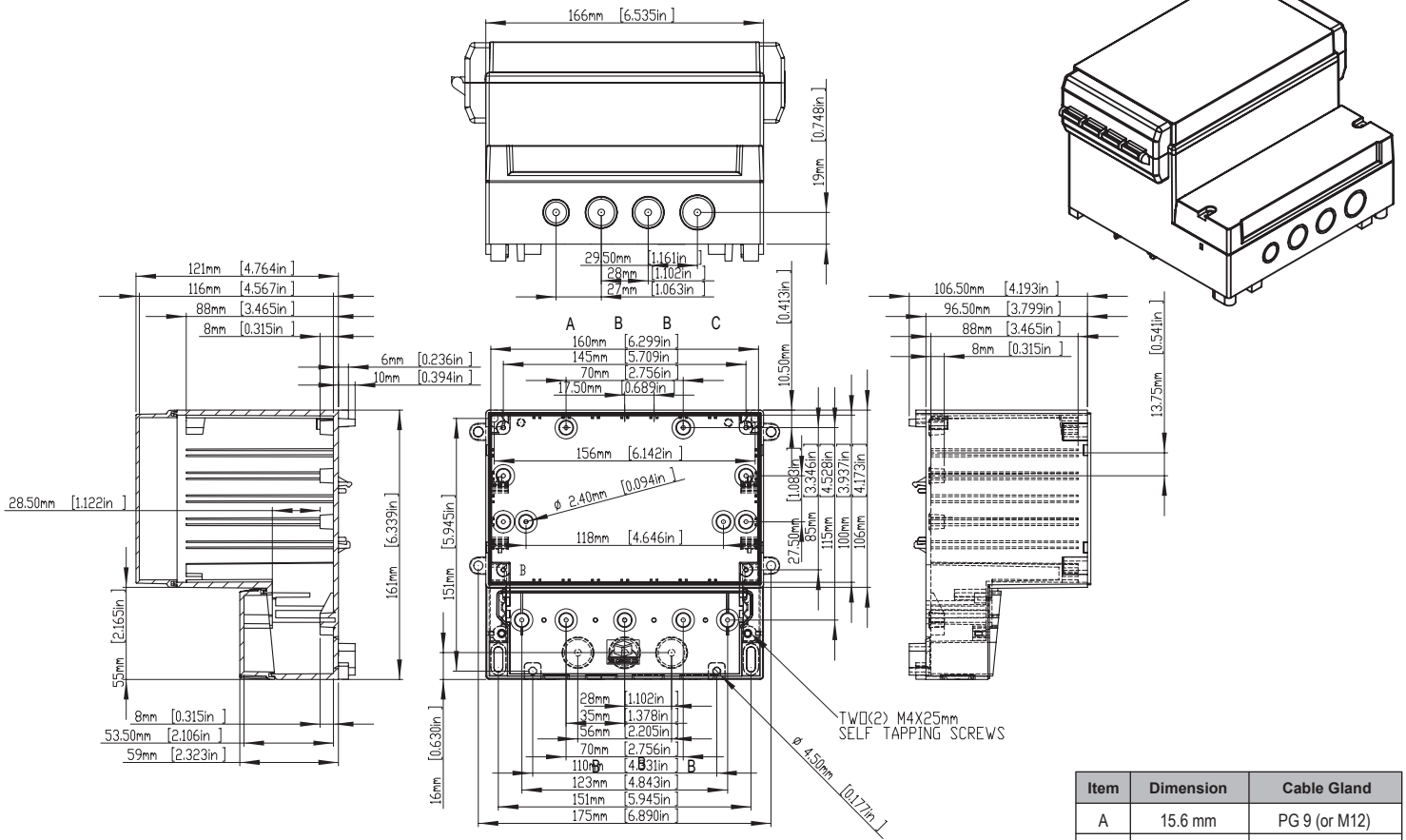

Item	Dimension	Cable Gland
A	15.6 mm	PG 9 (or M12)
B	19.0 mm	PG 11 (or M16)
C	20.8 mm	PG 13.5 (or M20)

## DC003CBUNO/DC003LGNO

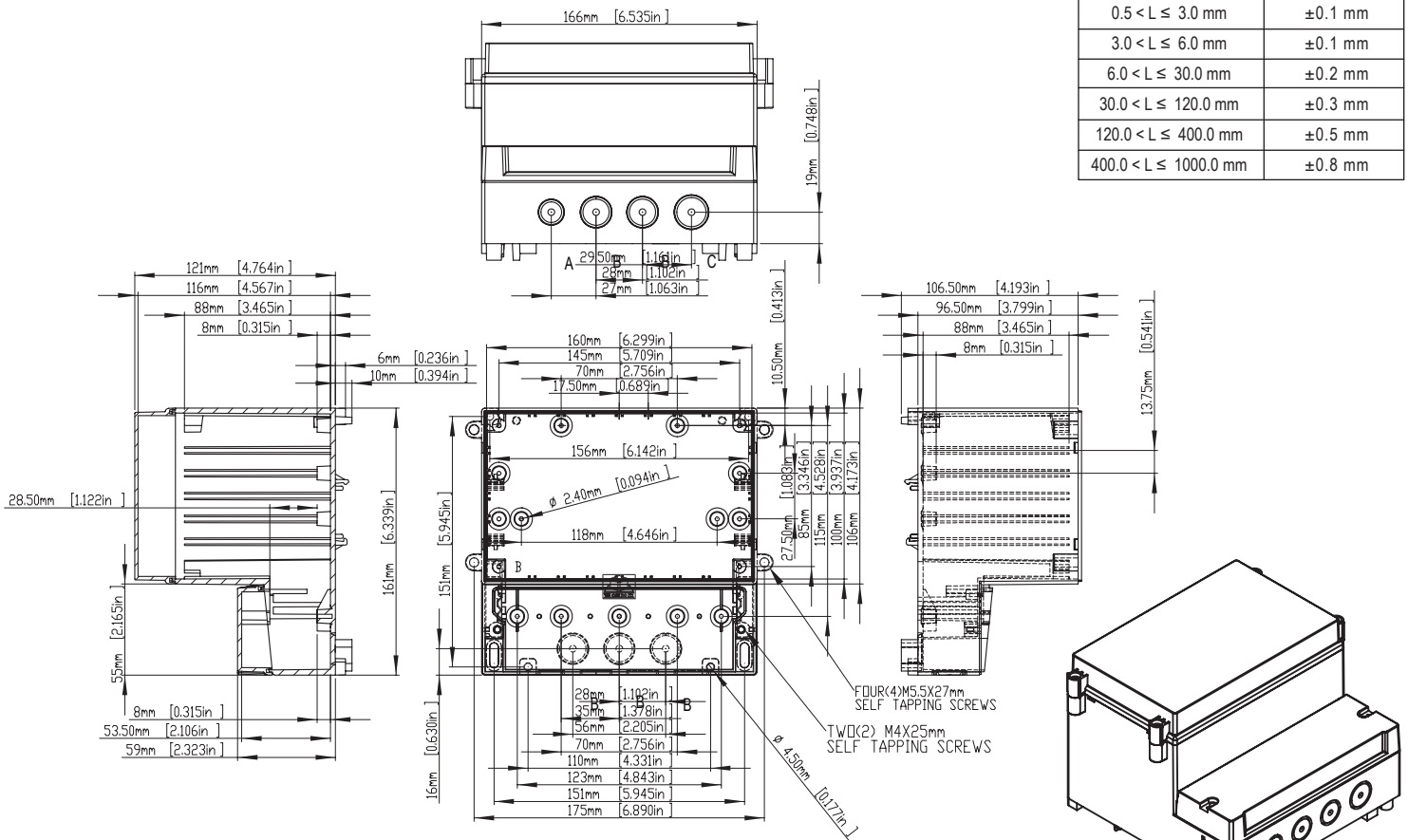

According to ISO 2768-m	
Measuring DIM=L	Tolerances
0.5 < L ≤ 3.0 mm	±0.1 mm
3.0 < L ≤ 6.0 mm	±0.1 mm
6.0 < L ≤ 30.0 mm	±0.2 mm
30.0 < L ≤ 120.0 mm	±0.3 mm
120.0 < L ≤ 400.0 mm	±0.5 mm
400.0 < L ≤ 1000.0 mm	±0.8 mm

# DC005CUL/DC005CBU

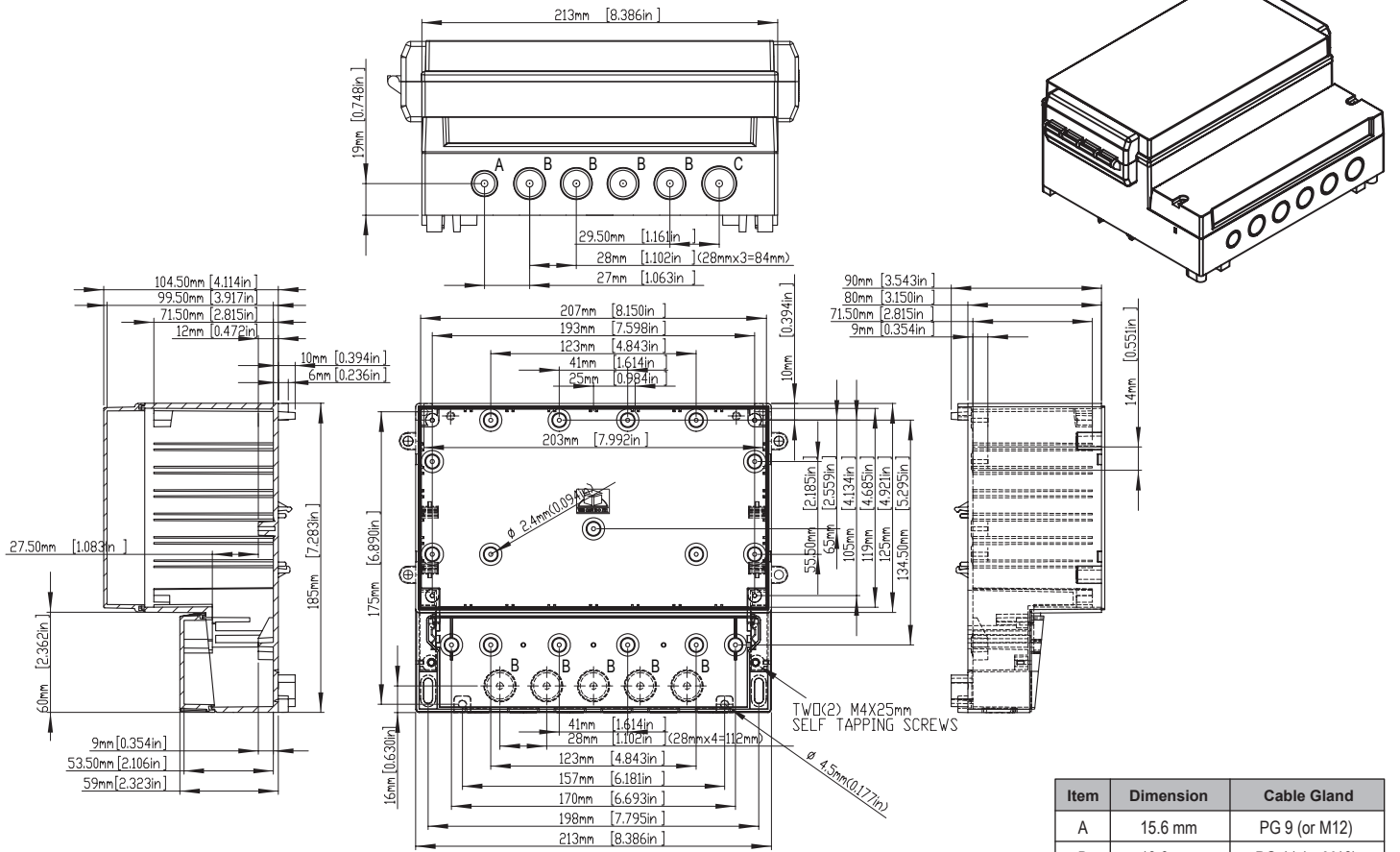

Item	Dimension	Cable Gland
A	15.6 mm	PG 9 (or M12)
B	19.0 mm	PG 11 (or M16)
C	20.8 mm	PG 13.5 (or M20)

# DC005CBUNO/DC005LGNO

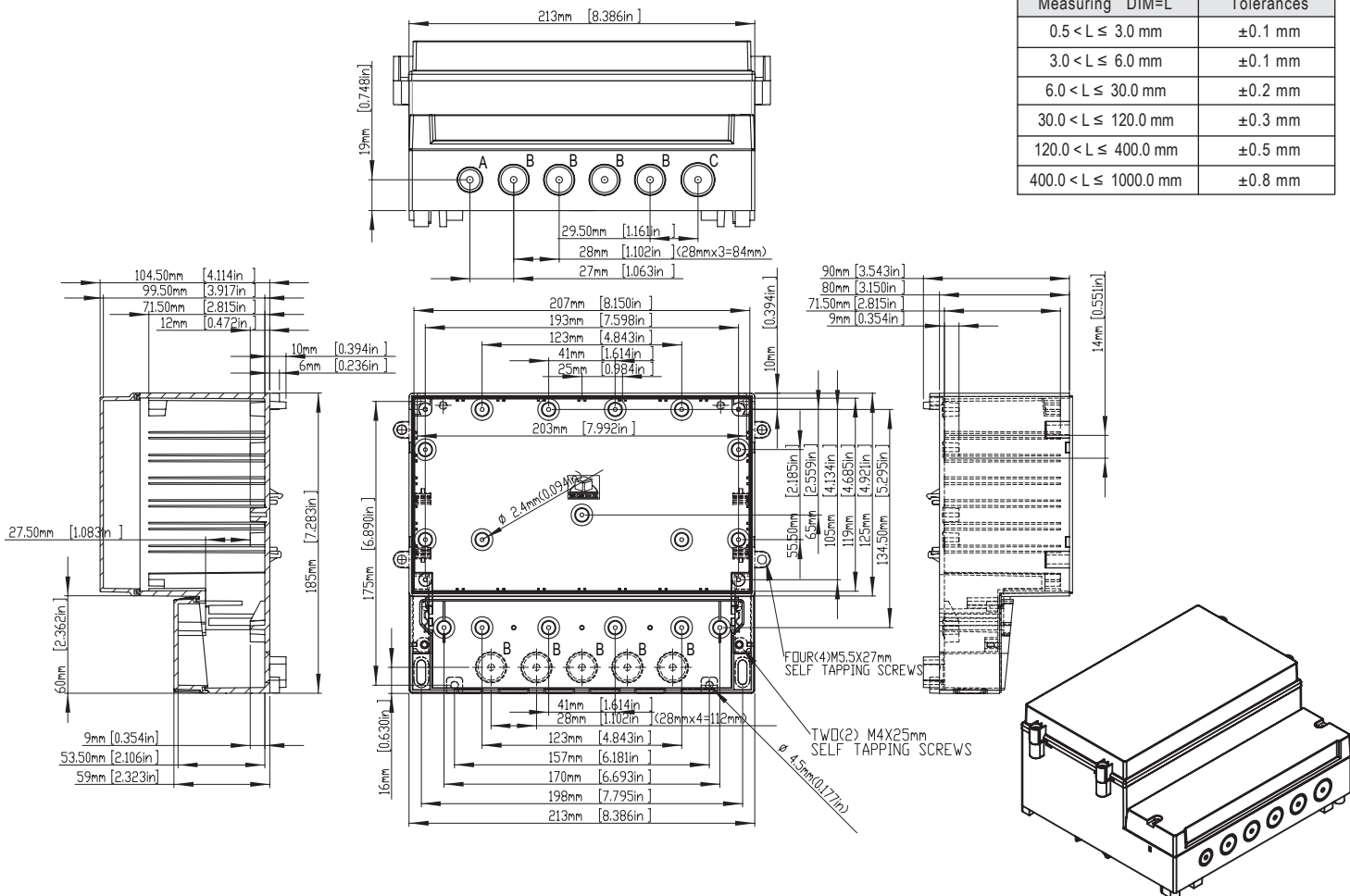

According to ISO 2768-m	
Measuring DIM=L	Tolerances
0.5 < L ≤ 3.0 mm	±0.1 mm
3.0 < L ≤ 6.0 mm	±0.1 mm
6.0 < L ≤ 30.0 mm	±0.2 mm
30.0 < L ≤ 120.0 mm	±0.3 mm
120.0 < L ≤ 400.0 mm	±0.5 mm
400.0 < L ≤ 1000.0 mm	±0.8 mm

## DC007CUL/DC007CBU

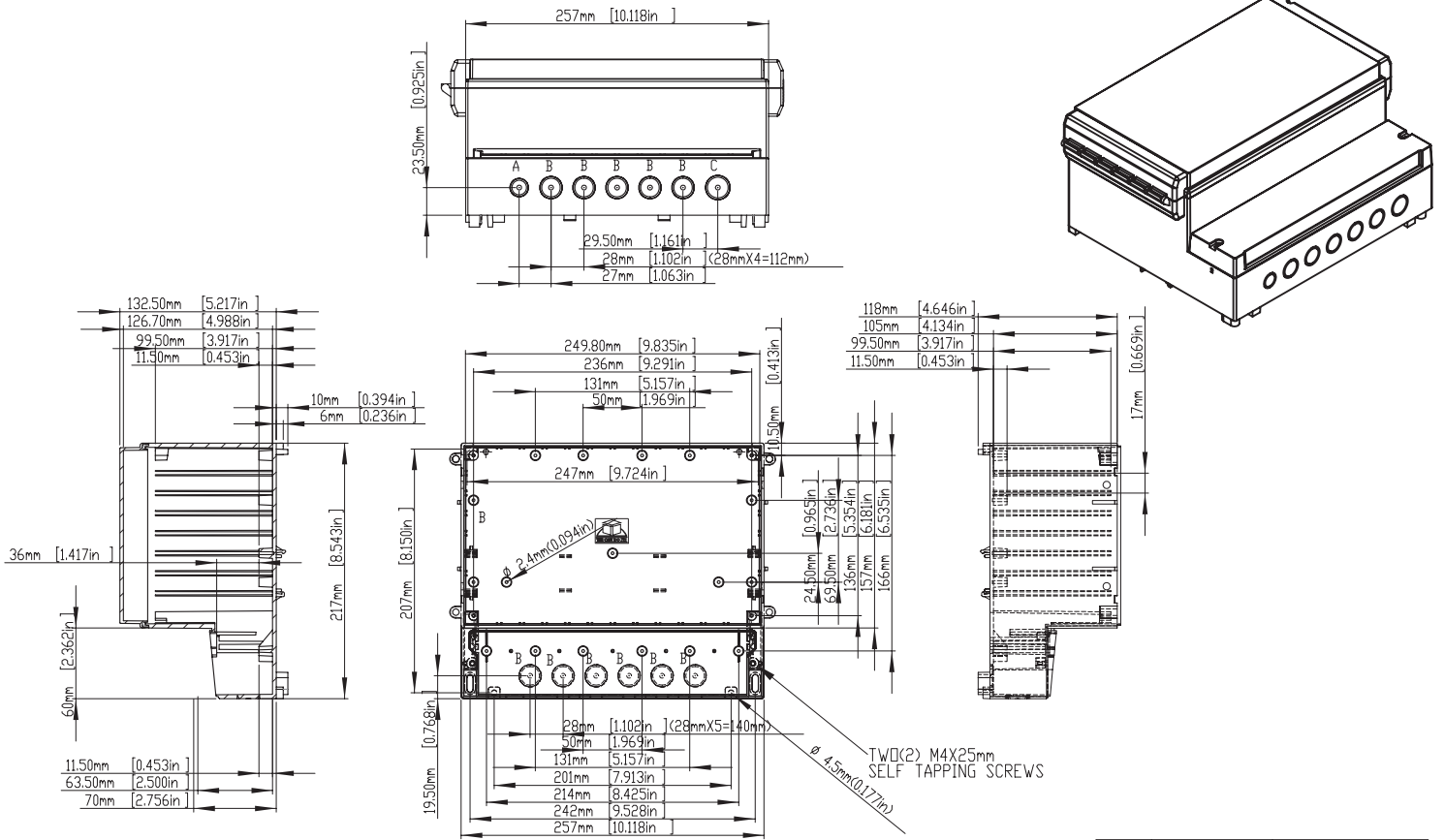

Item	Dimension	Cable Gland
A	15.6 mm	PG 9 (or M12)
B	19.0 mm	PG 11 (or M16)
C	20.8 mm	PG 13.5 (or M20)

## DC007CBUNO/DC007LGNO

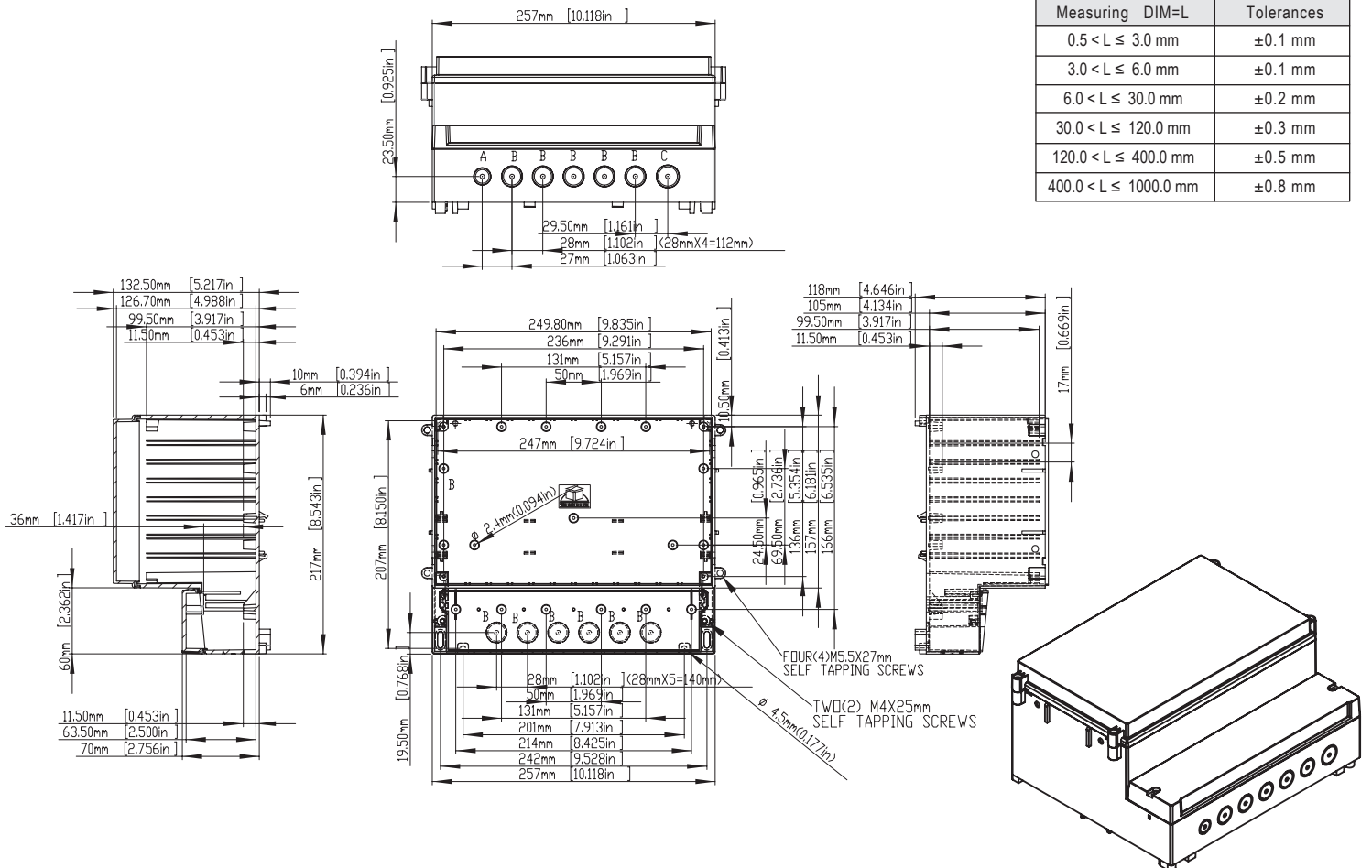

According to ISO 2768-m	
Measuring DIM=L	Tolerances
0.5 < L ≤ 3.0 mm	±0.1 mm
3.0 < L ≤ 6.0 mm	±0.1 mm
6.0 < L ≤ 30.0 mm	±0.2 mm
30.0 < L ≤ 120.0 mm	±0.3 mm
120.0 < L ≤ 400.0 mm	±0.5 mm
400.0 < L ≤ 1000.0 mm	±0.8 mm



## DC009CUL/DC009CBU

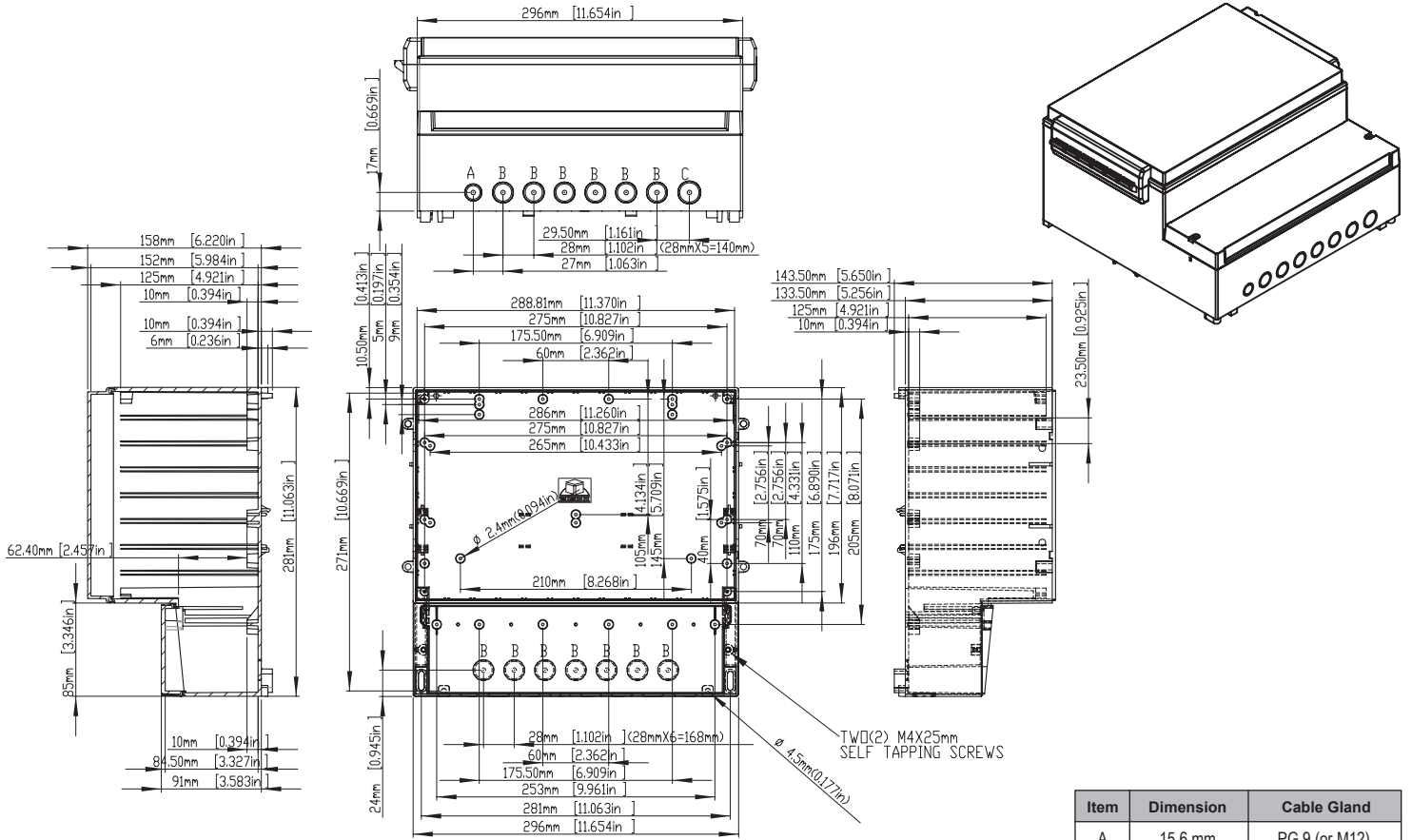

Item	Dimension	Cable Gland
A	15.6 mm	PG 9 (or M12)
B	19.0 mm	PG 11 (or M16)
C	20.8 mm	PG 13.5 (or M20)

## DC009CBUNO/DC009LGNO

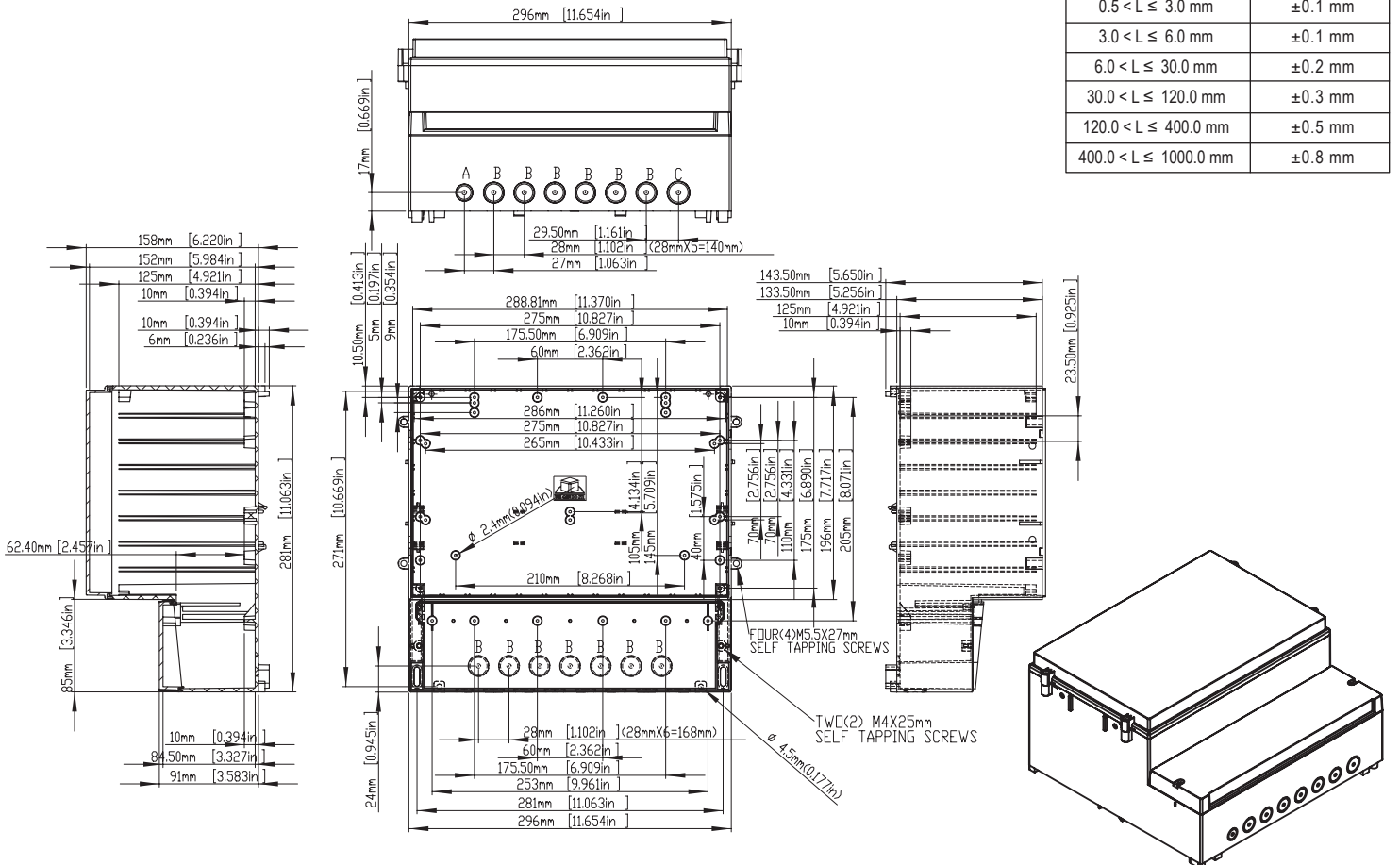

According to ISO 2768-m	
Measuring DIM=L	Tolerances
0.5 < L ≤ 3.0 mm	±0.1 mm
3.0 < L ≤ 6.0 mm	±0.1 mm
6.0 < L ≤ 30.0 mm	±0.2 mm
30.0 < L ≤ 120.0 mm	±0.3 mm
120.0 < L ≤ 400.0 mm	±0.5 mm
400.0 < L ≤ 1000.0 mm	±0.8 mm