

M3X4mm SELF-TAPPING SCREWS  
(NOT SUPPLIED).

Four(4) M4X20mm  
PAN HEAD SCREWS.

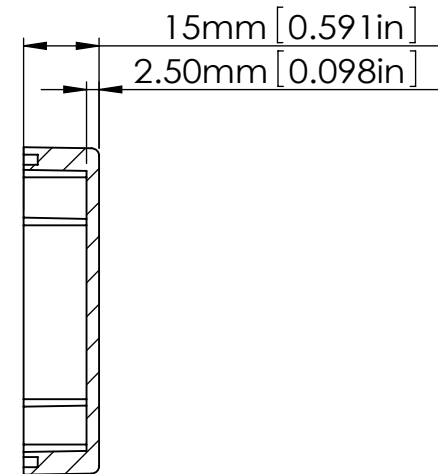

SECTION B-B  
SCALE 2 : 3

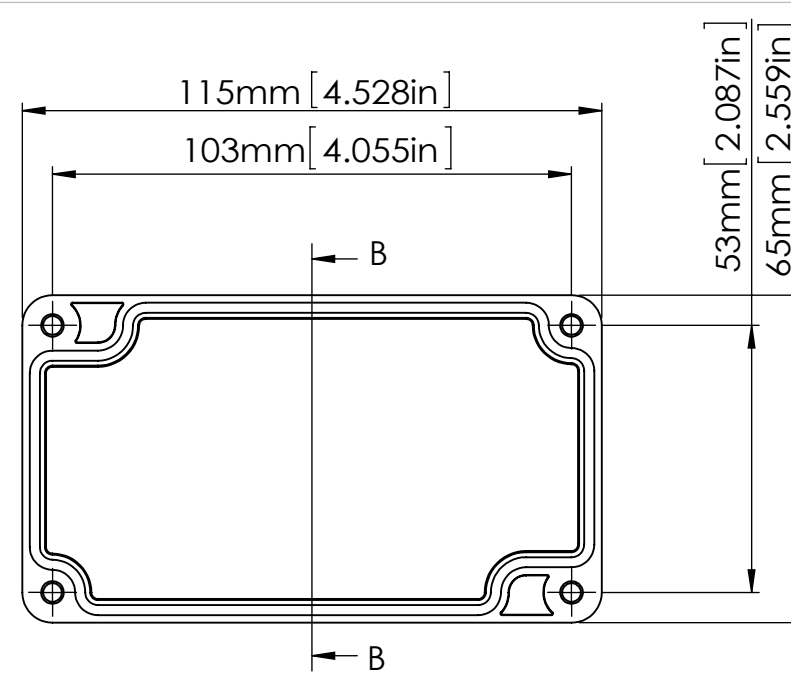
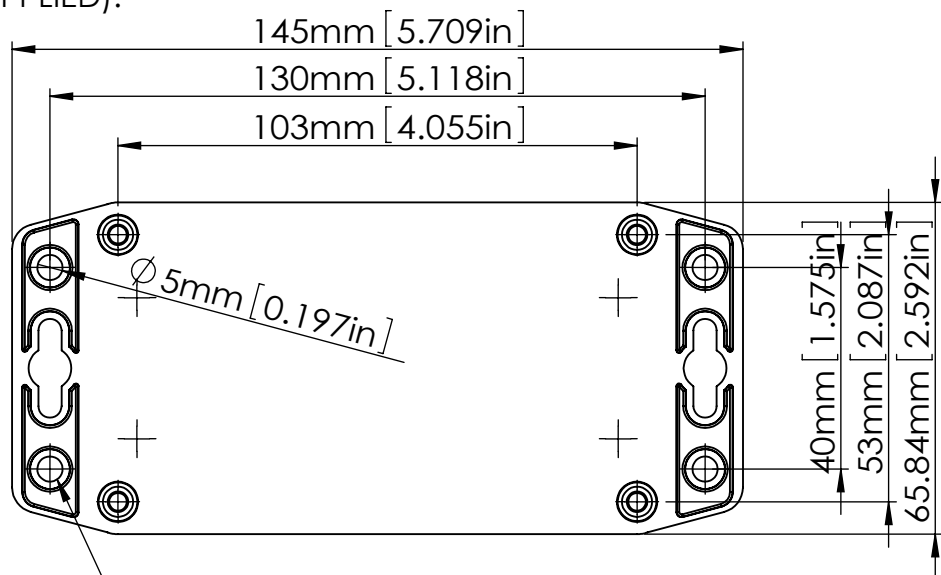

HOLES(4) ARE DESIGNED FOR M4 PAN HEAD  
SCREWS(NOT SUPPLIED).

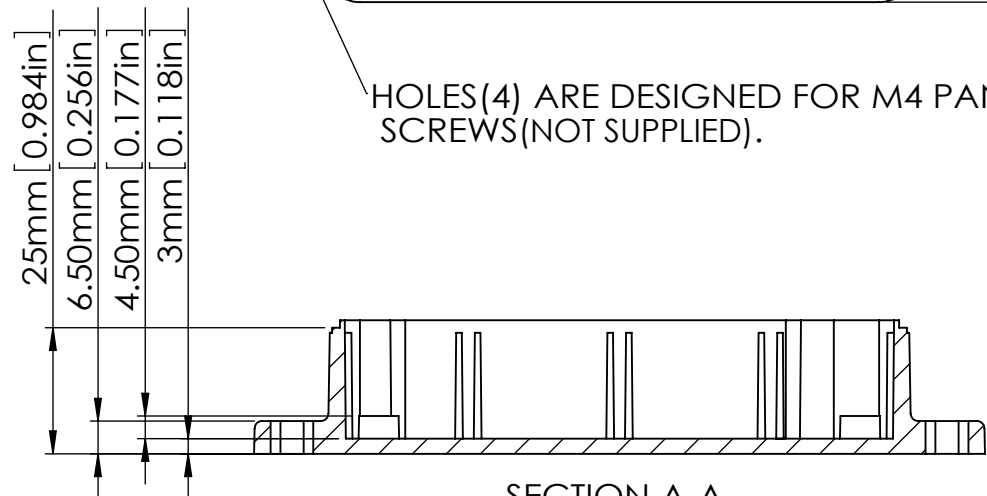

SECTION A-A  
SCALE 2 : 3

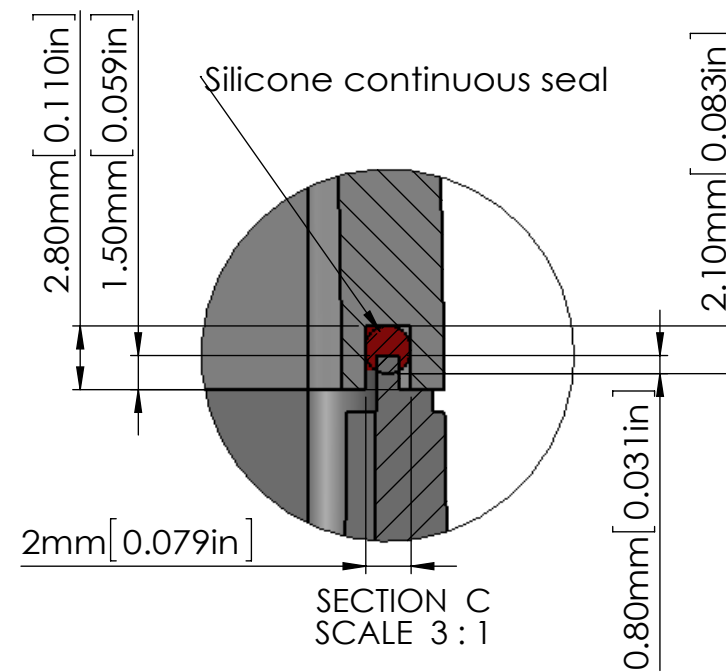

SECTION C  
SCALE 3 : 1

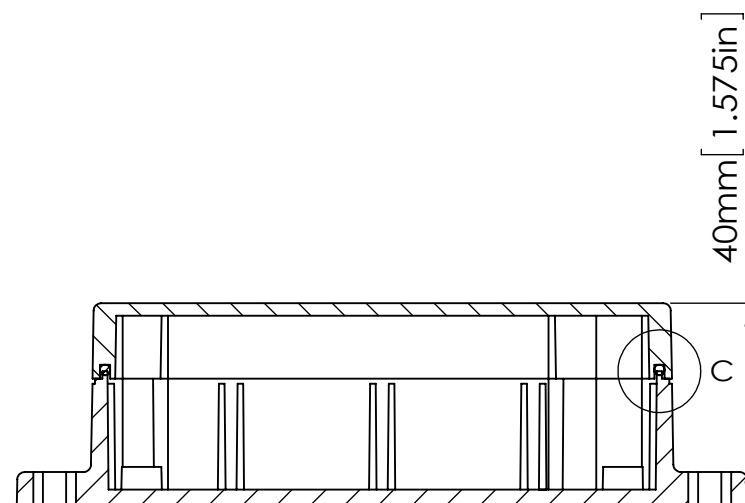

ASSEMBLY

According to ISO 2768-m	
Measuring DIM=L	Tolerances
0.5<L<=3.0mm	±0.1mm
3.0<L<=6.0 mm	±0.1mm
6.0<L<=30.0 mm	±0.2mm
30.0<L<=120.0 mm	±0.3mm
120.0<L<=400.0 mm	±0.5mm
400.0<L<=1000.0 mm	±0.8mm

宣又實業有限公司  
GAINTA INDUSTRIES LTD.

繪圖 DRA'D BY  
JACKY

日期 DATE  
2020/03/10

材質 MATE.  
PC/ABS

圖名TITLE:  
P203MF-IP68/A304MF-IP68

圖號DWG NO:

版次REVISID:

A

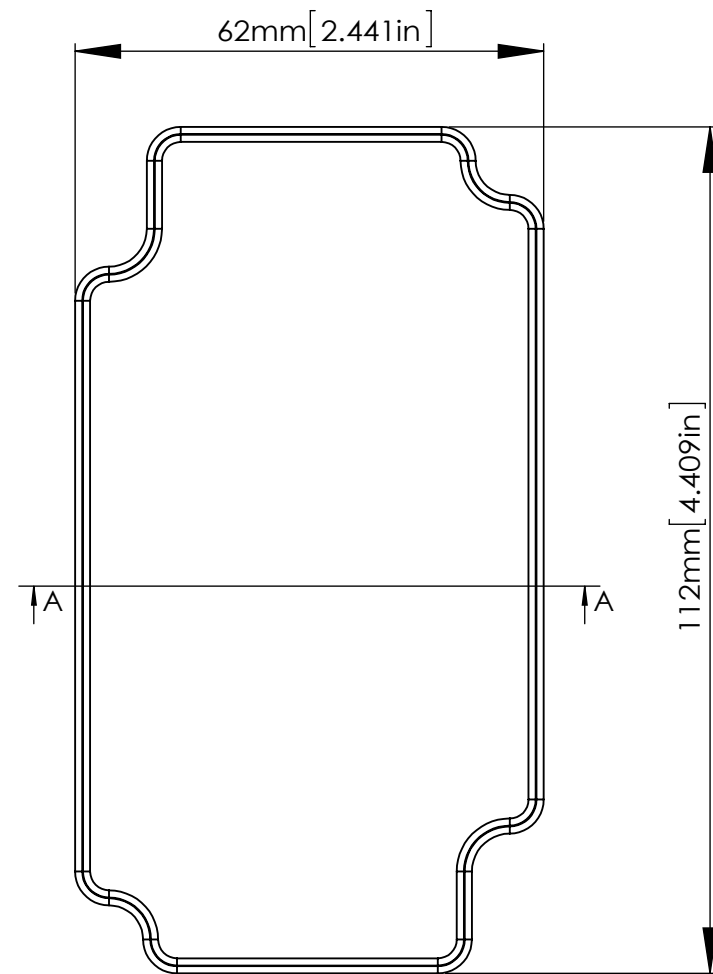

SECTION A-A  
SCALE 1:1

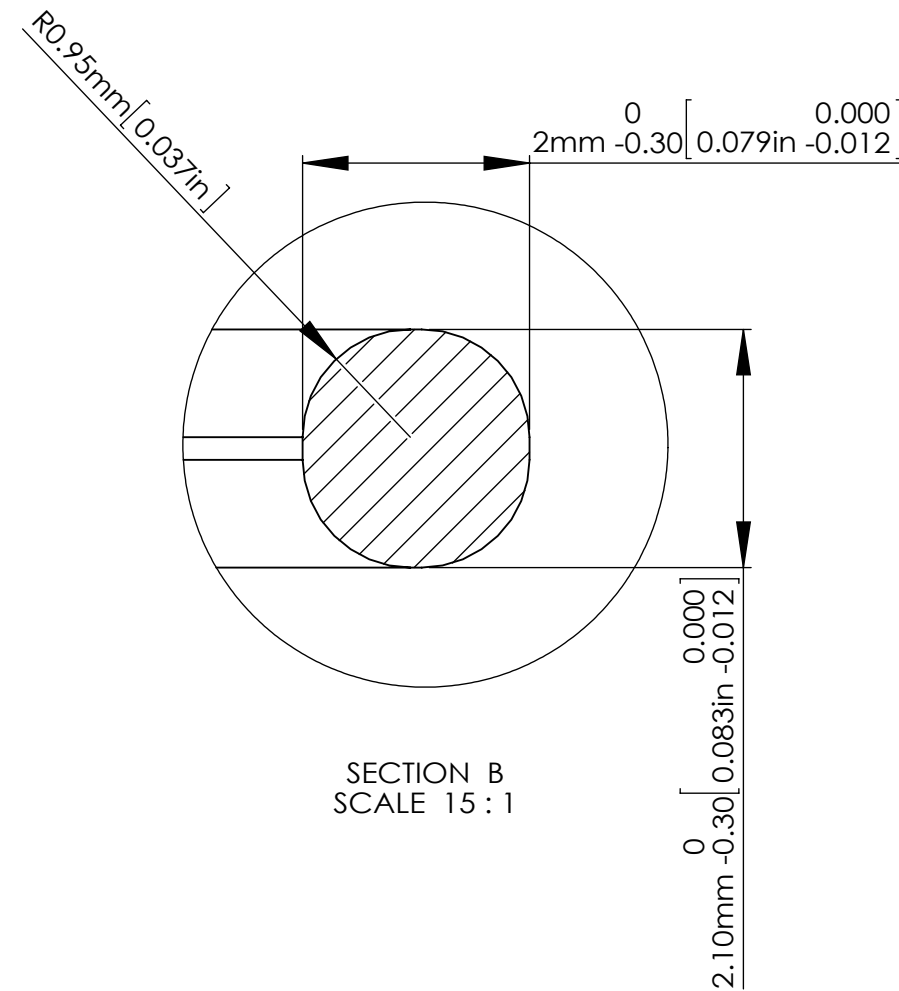

SECTION B  
SCALE 15:1

According to ISO 2768-m	
Measuring DIM=L	Tolerances
0.5<L<=3.0mm	±0.1mm
3.0<L<=6.0 mm	±0.1mm
6.0<L<=30.0 mm	±0.2mm
30.0<L<=120.0 mm	±0.3mm
120.0<L<=400.0 mm	±0.5mm
400.0<L<=1000.0 mm	±0.8mm

宣又實業有限公司  
GAINTA INDUSTRIES LTD.

繪圖 DRA'D BY  
JACKY

日期 DATE  
2020/02/20

材質 MATE.  
SILICONE

圖名TITLE:  
P203SEAL/A304SEAL;  
P205SEAL/A308SEAL

圖號DWG NO:

版次REVISED:  
A