

SECTION A-A
SCALE 2:3

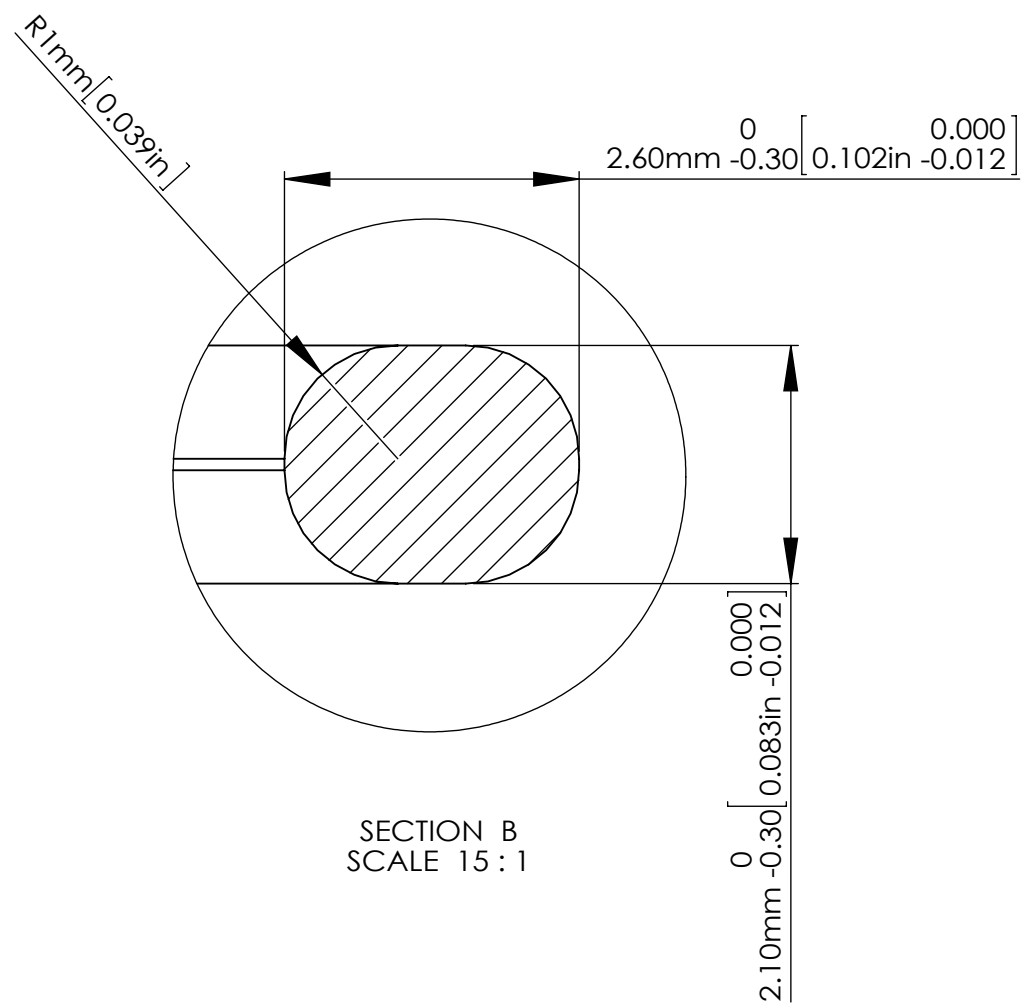

SECTION B
SCALE 15:1

According to ISO 2768-m	
Measuring DIM=L	Tolerances
0.5<L<=3.0mm	±0.1mm
3.0<L<=6.0 mm	±0.1mm
6.0<L<=30.0 mm	±0.2mm
30.0<L<=120.0 mm	±0.3mm
120.0<L<=400.0 mm	±0.5mm
400.0<L<=1000.0 mm	±0.8mm

宣又實業有限公司
GAINTA INDUSTRIES LTD.

繪圖 DRA'D BY
JACKY

日期 DATE
2020/02/20

材質 MATE.
SILICONE

圖名TITLE:
P2691SEAL/A3735SEAL

圖號DWG NO:

版次REVISED:

A